

ChowHUB



User Manual

For Universal Smartphone
Control HUB



Download on the
App Store

GET IT ON
Google play

www.tmt-automation.com

Index

Introduction of the ChowHUB	P2
Product overview	P2
Kit contents	P3
Specifications	P3
Installation guide	P4
Wire connection cycle mode	P5
Wire connection open/stop/close mode	P6
Apply for a new Chow account	P8
Connecting the ChowHUB to the Chow! App	P9
Setting of Chow!APP cycle mode	P10
Setting of Chow!APP open/stop/close mode	P10
Operation page	P11
Wireless door sensor	P11
Pairing remotes	P13
Account management page	P15
Push notification	P15
Owner shares device	P16
FAQ	P17



Introduction of the ChowHUB

This user manual is designed to provide indications of the ChowHUB and its features and functions

ChowHUB is a device can upgrade the existing automation system to become a smartphone control unit through TMT Chow! APP

ChowHUB can intergrade with other TMT IOT accessories such as ChowCAM and ChowBELL on the Chow! APP

Product overview

Universal stand-alone Wi-Fi HUB

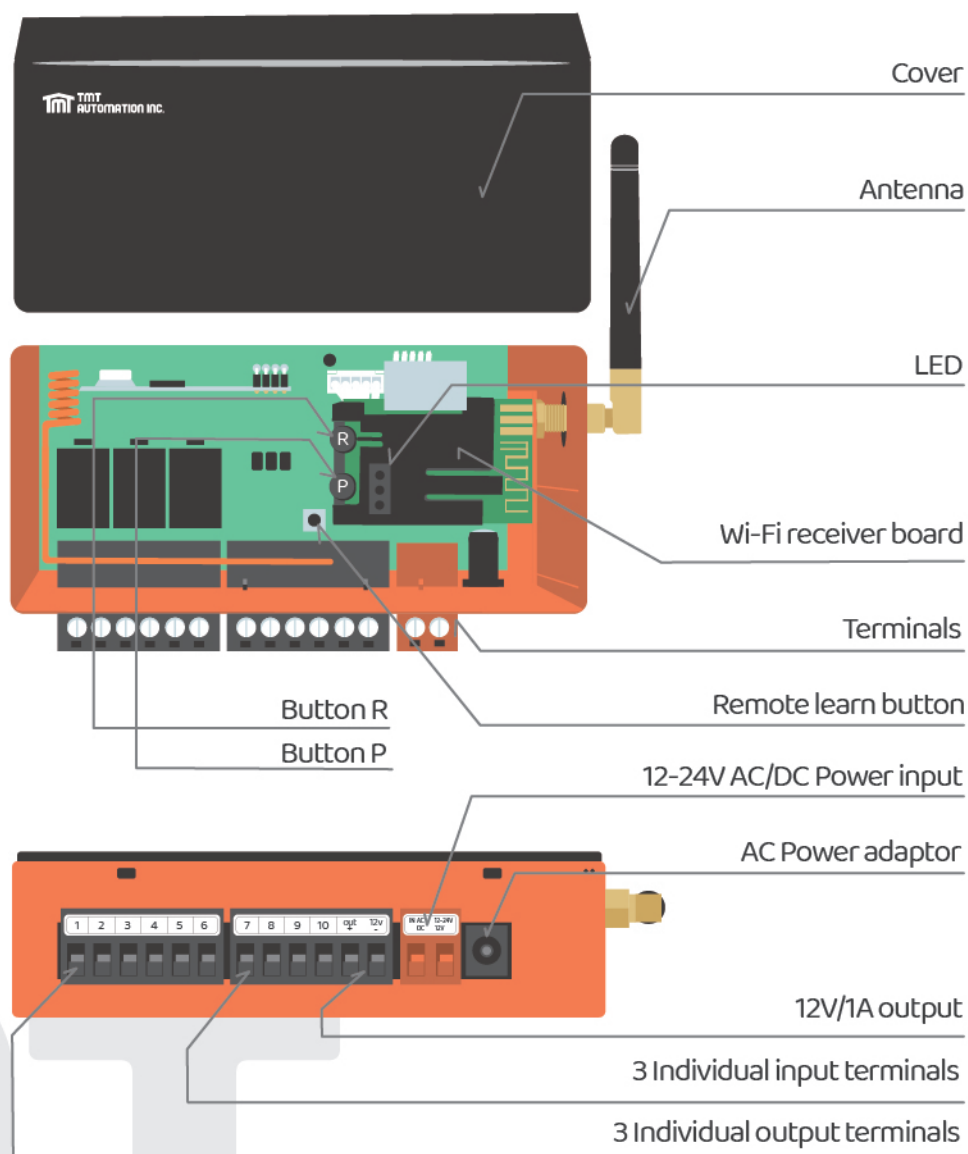

Kit contents

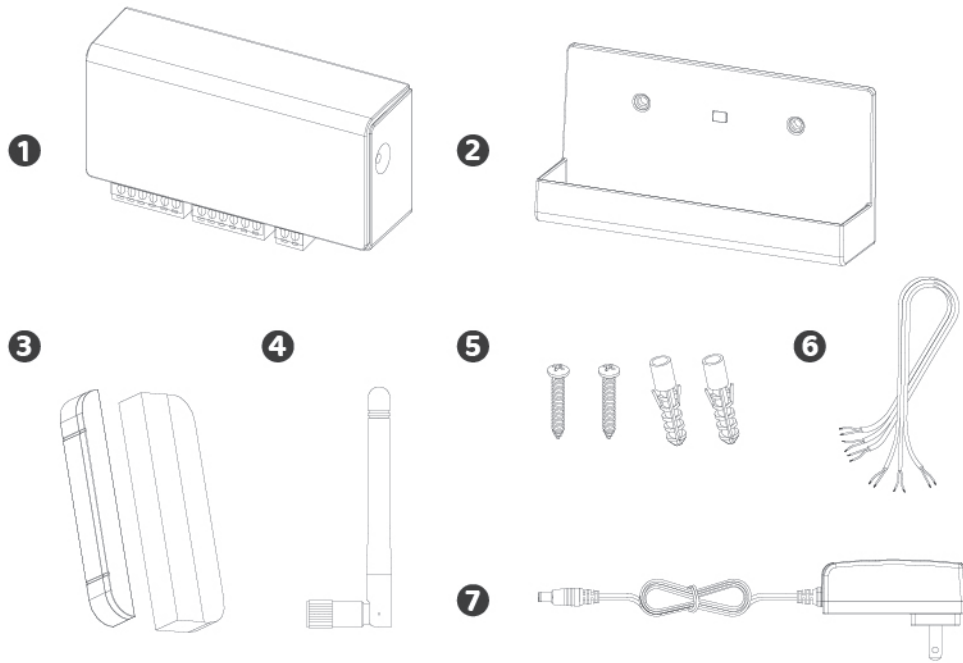

- 1** ChowHUB **2** Holder **3** Door Status sensor **4** Antenna
5 Expansion screws **6** Wire*3pcs **7** Power plug

Specifications

Frequency	433 Mhz and 2.4GHz
Working temperature	-20°C~70°C
Dimensions	56x110x35mm
Power	AC/DC, 12V/24V, 1A

Installation guide

General Installation

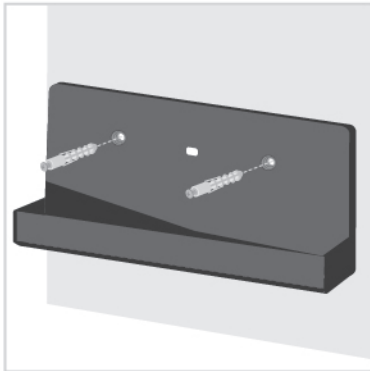

- 1 Measure the drilling positions for the expansion screws with the holder.
Fasten the holder with the expansion screws to the wall.

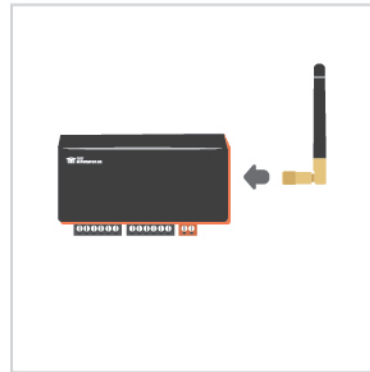

- 2 Install the antenna on the ChowHUB



- 3 The ChowHUB will magnetically be attached to the holder.



- 4 Attach the power plug to the ChowHUB. The blue LED will blink right after it's plug in, and the ChowHUB will be ready for pairing.

Wire connection cycle mode

1. Please connect **1** and **2** terminals to the push button terminal of your gate automation.
7 is the terminal for a wired limit switch that sends signal to your smart phone when triggered.

Please refer to the manual of your automation to find the push button terminal

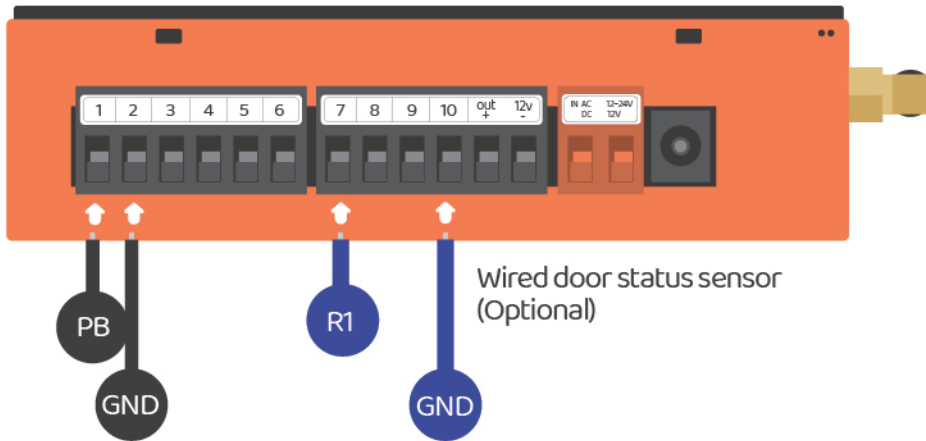

2. To control a second device. Please connect **3** and **4** terminals to the push button terminal of your gate automation.
8 is the terminal for second wired limit switch that sends signal to your smart phone when triggered.

Please refer to the manual of your automation to find the push button terminal

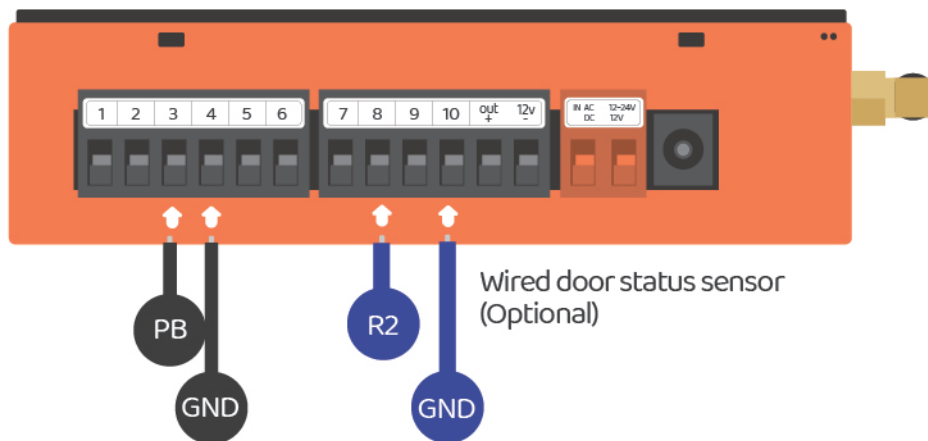

Wire connection open/stop/close mode

Before connection, please make sure your gate automation system has open/stop/close terminal.

⑦ Is the terminal for a wired limit switch which sends signal to your smartphone when triggered.

*****Please refer to the manual of your automation to find the open/stop/close terminal*****

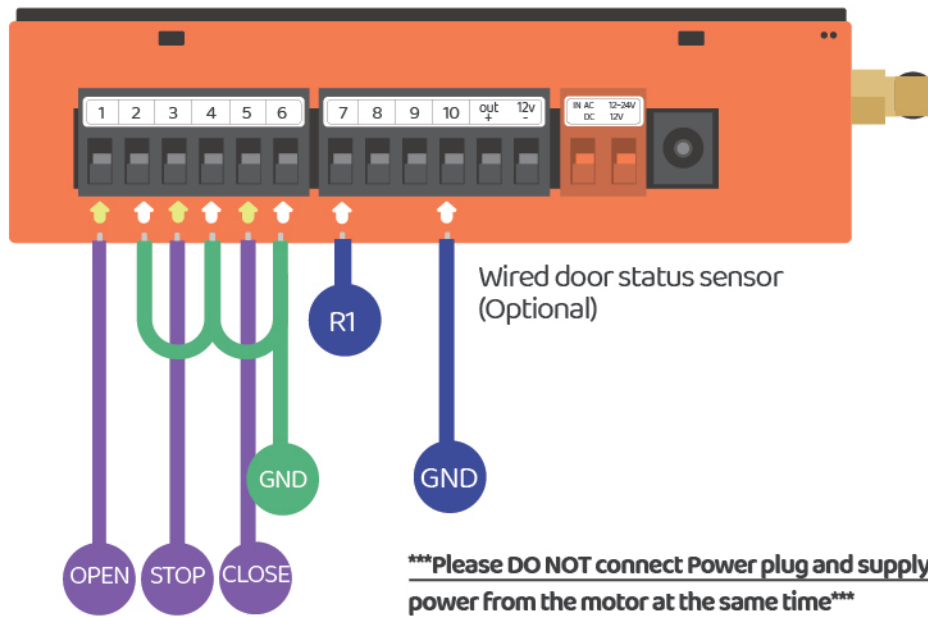

Scenario 1

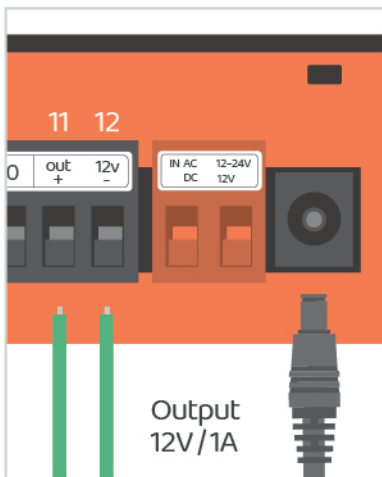





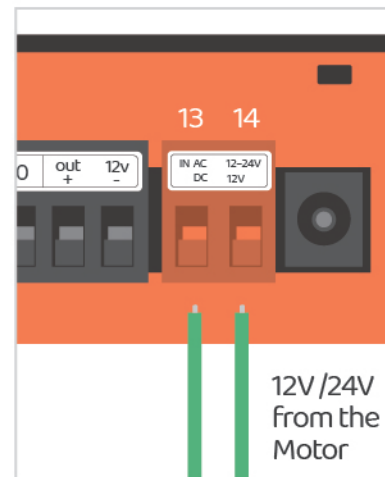



Terminal ⑪ and ⑫ supply 12V/1A when connect to Power plug

Scenario 2



Terminal ⑬ and ⑭ become 12V/24V input terminals which can take AC or DC power from the motor

Output terminals

3 Outputs	Outputs #1 (APP-Door1)		Outputs #2 (APP-Door2)		Outputs #3 (APP-Door3)	
ChowHUB terminal	1	2	3	4	5	6
Device terminal	PB/ Push button	GND	PB/ Push button	GND	PB/ Push button	GND
	Default NO Circuit		Default NO Circuit		Default NO Circuit	
APP parameter setting	 Relay1 Mode NO		 Relay2 Mode NO		 Relay3 Mode NO	
	 Relay1 Mode NC		 Relay2 Mode NC		 Relay3 Mode NC	
	 Relay1 Mode None		 Relay2 Mode None		 Relay3 Mode None	

Input terminals

3 Inputs	Inputs #1		Inputs #2		Inputs #3	
ChowHUB terminals	7	10	8	10	9	10
Wire trigger device	Sensor 1	GND	Sensor 2	GND	Sensor 3	GND
APP parameter setting	Trigger mode 1 (Default) NO circuit NC-NO ➡ OPEN; NC-CO ➡ CLOSE					
	Trigger mode 2 NC circuit NC-NO ➡ OPEN; NC-CO ➡ CLOSE					
	Function OFF					

Apply for a new Chow account

1. Please scan the QR code and download the Chow! App
2. Press sign up icon and press the agree icon to continue
3. Please type the following information for registration:



- a. Email (enter twice for verification)
- b. Password (enter twice for verification)
- c. The password should have at least 1 English character and at least 8 characters/numbers in total

4. The system will send a link to your email when the registration succeeds
5. Please go to your email, and click the link to activate your Chow account
6. Please log in to your Chow account

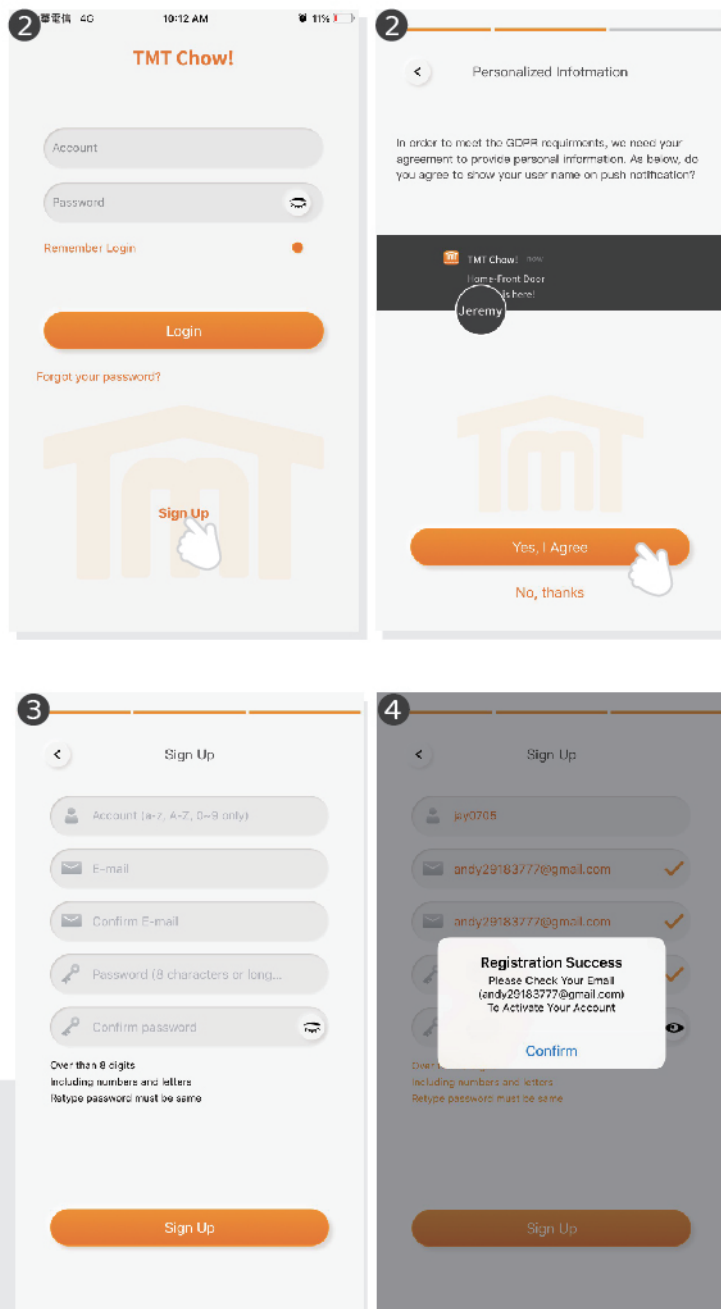

Connecting the ChowHUB to the Chow! App

For initial setup, check if the blue indication light is flashing
IF not, please follow below procedures to reset the device.

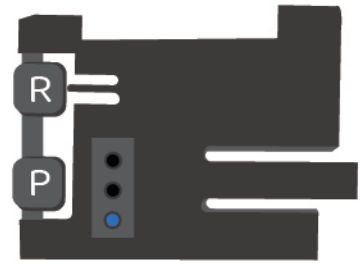

1. Press the **P** button for 5 seconds
2. Press the **R** button once

1. Connect the smartphone to your home Wi-Fi network before you start to setup the ChowHUB.

*****ChowHUB is ONLY compatible with 2.4GHz Wi-Fi network!*****
*****ChowHUB will be connected to the Wi-Fi network you choose.*****

2. Log in or sign up for Chow!APP.
3. Tap the (+) icon to add the device.
4. Tap the (ChowHUB) icon.
5. Enter the password for the Wi-Fi. **DO** make sure entering the correct password.
6. Tap on the ChowHUB icon on the (Find) device page

Set a PIN code for safety use. Once the PIN code is confirmed, the ChowHUB will appear on the main page for further operation.

**** The PIN code is required for other users to access to the ChowHUB.*****
**** The PIN code can be reset by pressing (P) and (R) button in the ChowHUB to default to the factory setting.*****

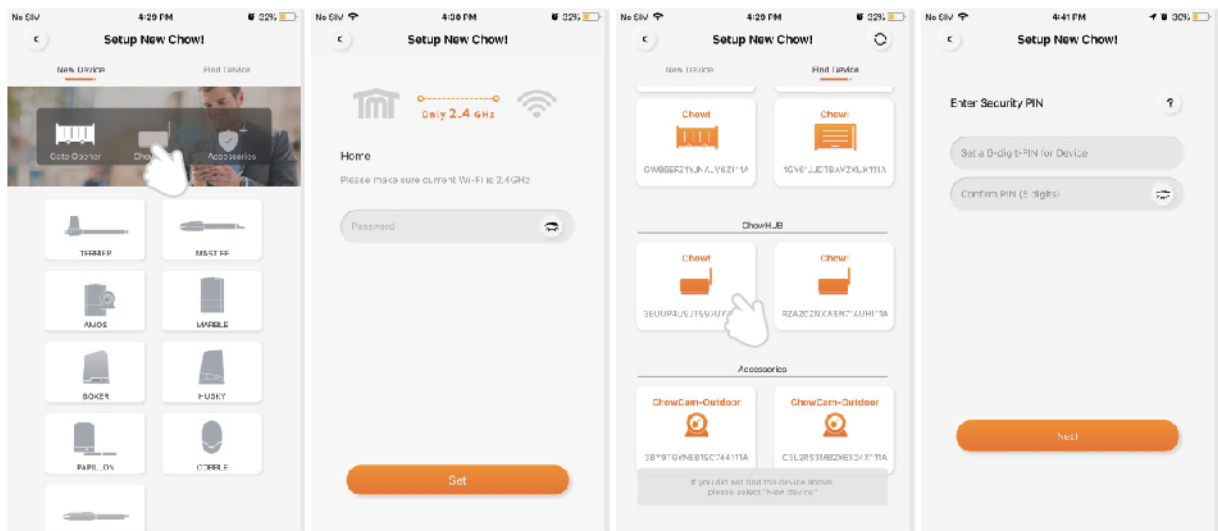

Make a successful ChowHUB setup with your home Wi-Fi

Suggest to bring the ChowHUB device close to the home Wi-Fi router as near as possible to receive the best Wi-Fi strength to make a successful connection, and make sure the home Wi-Fi source is 2.4G from the router not 5G, also must enter the correct password for the home Wi-Fi to complete the setup

After the ChowHUB has been successfully connect to your home Wi-Fi, you may connect the output to your automation system to start to operation.

Setting of Chow!APP cycle mode

1. Fill in the name of the device
2. Select the (cycle mode)
3. Select (wireless door sensor).

***** For the connection of wireless limit switch, please refer to Page 11 Wireless door sensor.*****

4. Select the corresponds door output (Door1 = Output 1)
 - ◆ enter the door name
 - ◆ choose the door type (different icon)
Garage door / Swing Gate / Sliding Gate
5. Lets get started !

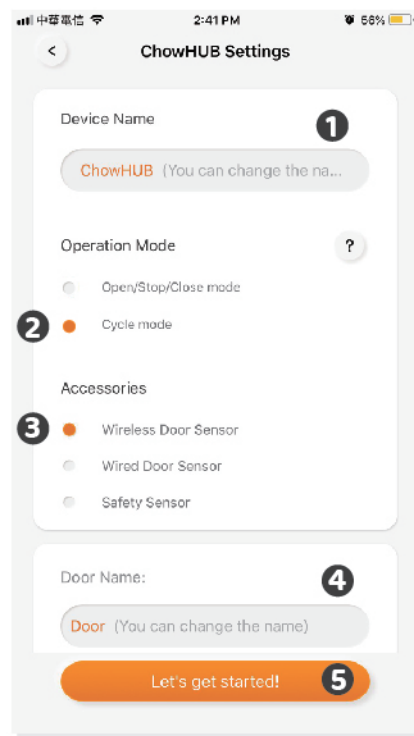

Setting of Chow!APP open/stop/close mode

1. Fill in the name of the device
2. Select the (open/stop/close mode)
3. Select (wireless door sensor).

****** For the connection of wireless door sensor, please refer to Page 11 Wireless door sensor.*****

4. Enter the door name
 - ◆ choose the door type (different icon)
◆ garage door / swing gate / sliding gate
5. Lets get started !
6. Select DC mode as the standard setting
7. Make the correct connection according to the diagram
Start to use

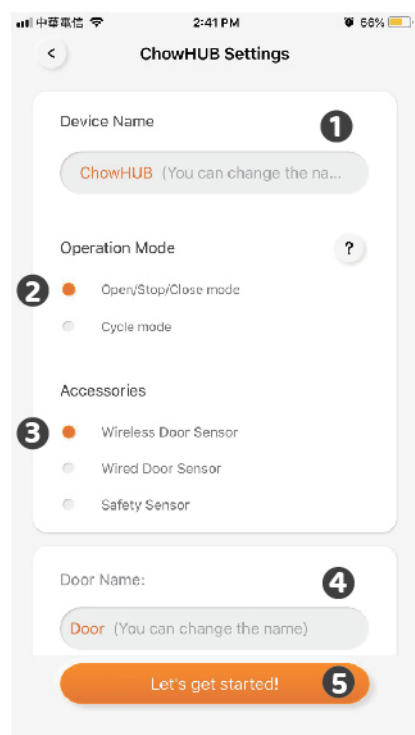

Operation page

1. Operation button
2. Switching bar for different device
3. Setting page
 - a. Device information
 - b. Edit or add devices
 - c. Available accessories
 - d. Parameter settings

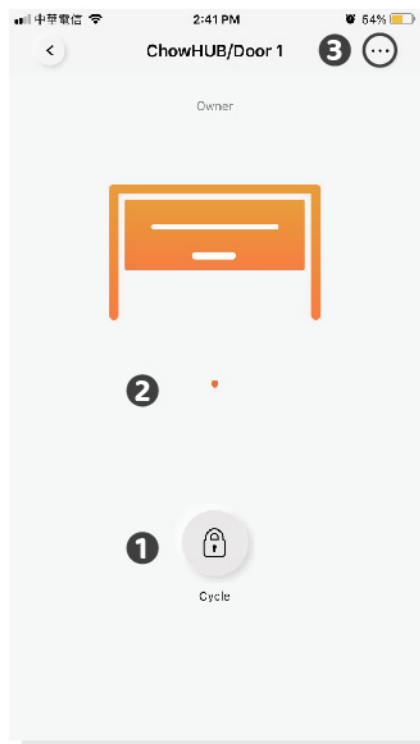

Wireless door sensor

Door sensor

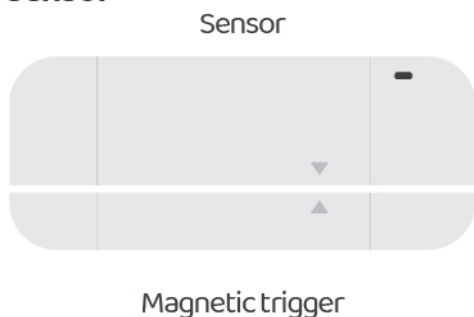

Door sensor consists of a magnetic trigger and a sensor. The Door sensor will send a signal when the gate opener reach the closed position.

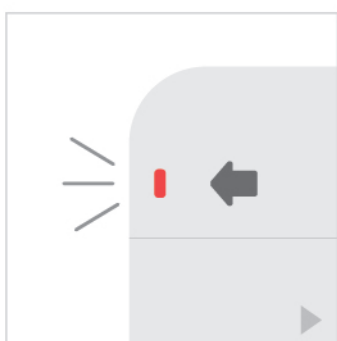

1 Pull out the isolation plate, and the LED will turn **ON** when the trigger close to the sensor.



2 Install the sensor at the door closed position.

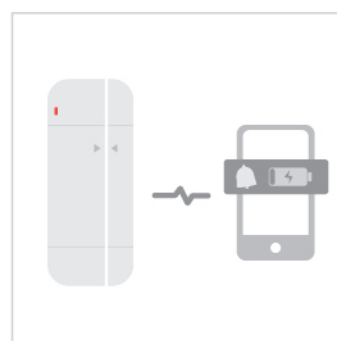

3 Door sensor will send notification if battery capacity is lower than 20%

Connect the Door sensor to Chow! APP

1. Tap the ChowHUB icon on the main page ➡ Entering the setting page
 ➡ Tap the (Edit or Add devices) ➡ Tap the (Pairing)
2. Align the trigger and sensor till the LED on the door sensor is ON.
3. The App shows (Learn Successfully).
4. The door sensor is recommended to be installed at the closed position of the gate or garage door.

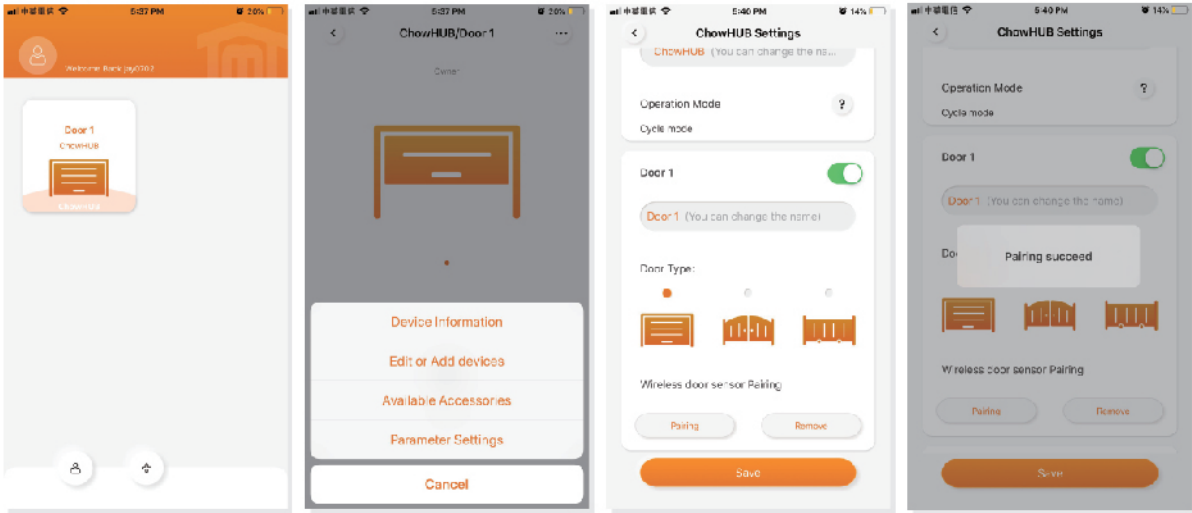

***** Please set stopper at the open limit position of the rack and after the setup is completed, then garage door opener can start the system learning process.*****

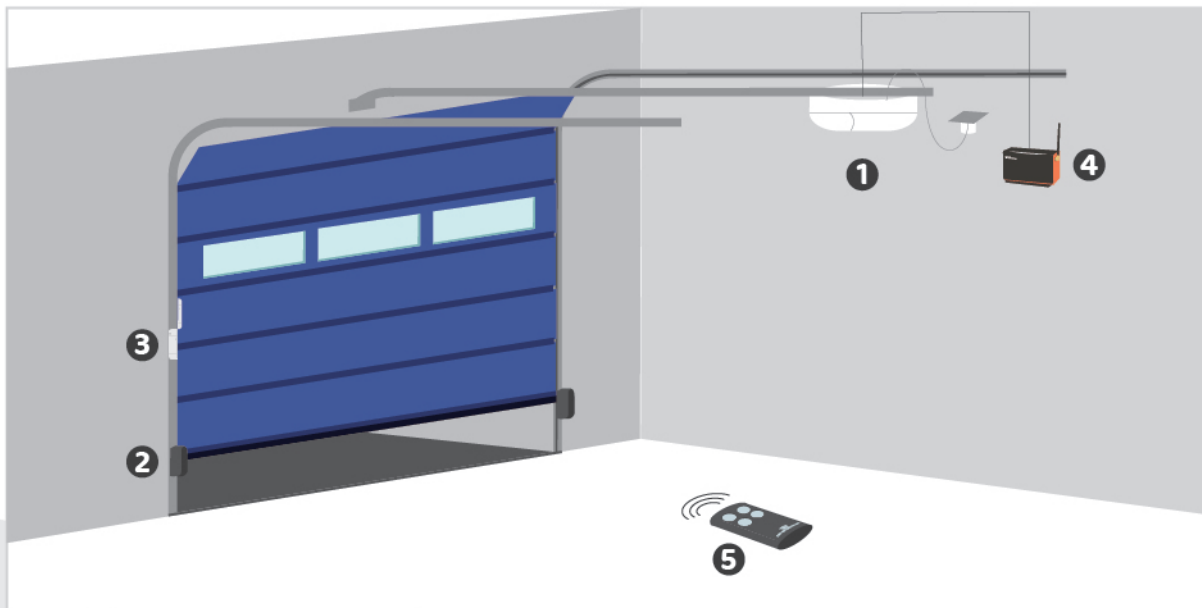

- 1** Cobble Garage Door Opener **2** Photocells (Optional accessories) **3** Door status sensor
4 ChowHUB **5** Transmitter

Pairing remotes

1. Please enter the Chow! App and tap on the ChowHUB icon on the main page
2. Please enter the setting page by tap the  icon
3. Enter the advanced page by enter the PIN code and find the remote learn function
4. Tap the remote learn and enter the PIN code again
5. Start the remote learn by tap the icon and the push notification will show start remote learning
6. Press any button of a remote and the push notification will show pairing success.
7. After 10 seconds, the remote learning mode will end automatically.

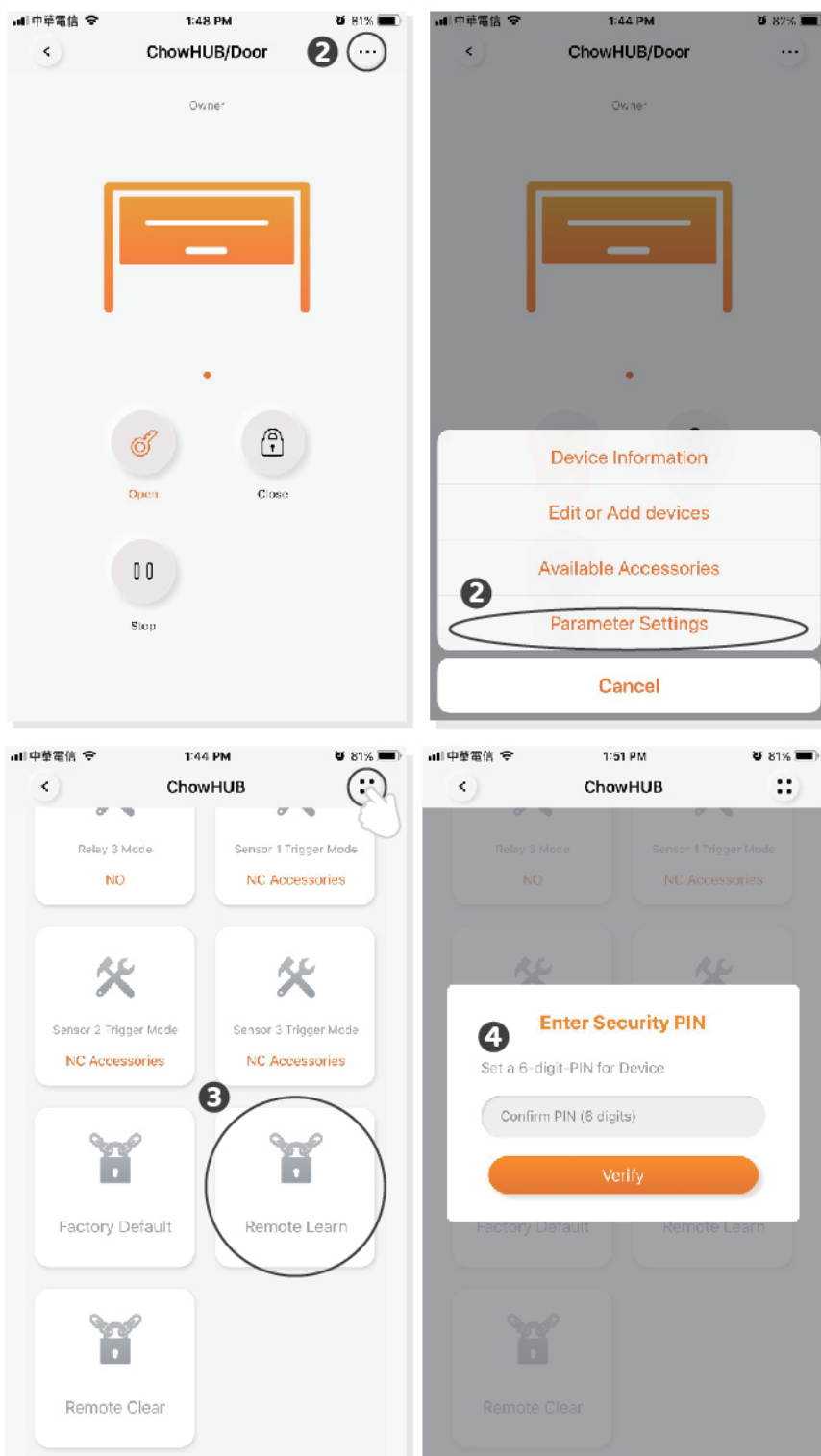

Pairing remotes with ChowHUB

1. Press the RF learning button for 3 second the red LED will turn **ON**.
2. Press any button of a remote and the red LED will blink.
3. After 10 seconds, the red LED will turn **OFF** and end the remote learning mode.

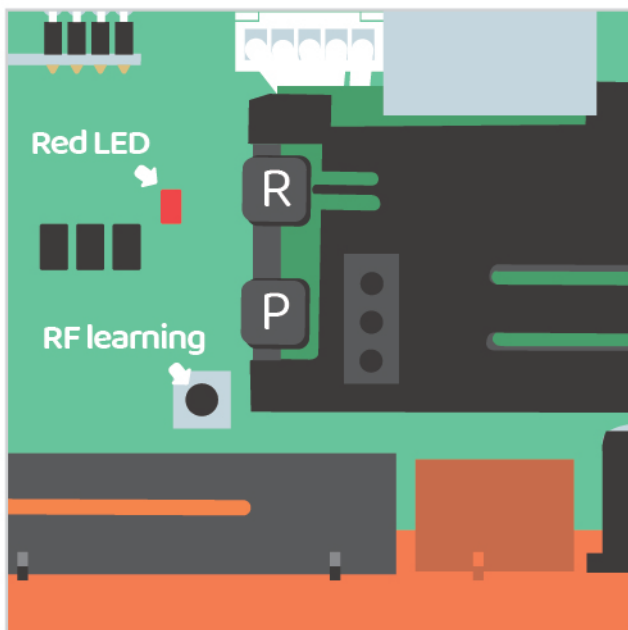

Pairing remotes with Chow! App



- A button: Trigger terminal **1 2**
- B button: Trigger terminal **3 4**
- C button: Trigger terminal **5 6**

Account management page

Push notification

1. Press the icon at the button left to enter the account management page.
2. Tap the push notification setting.
3. Turn **ON** the switches of the notification.

**** Please go to the settings page of your smartphone.
Find TMT chow and allow the notifications.****

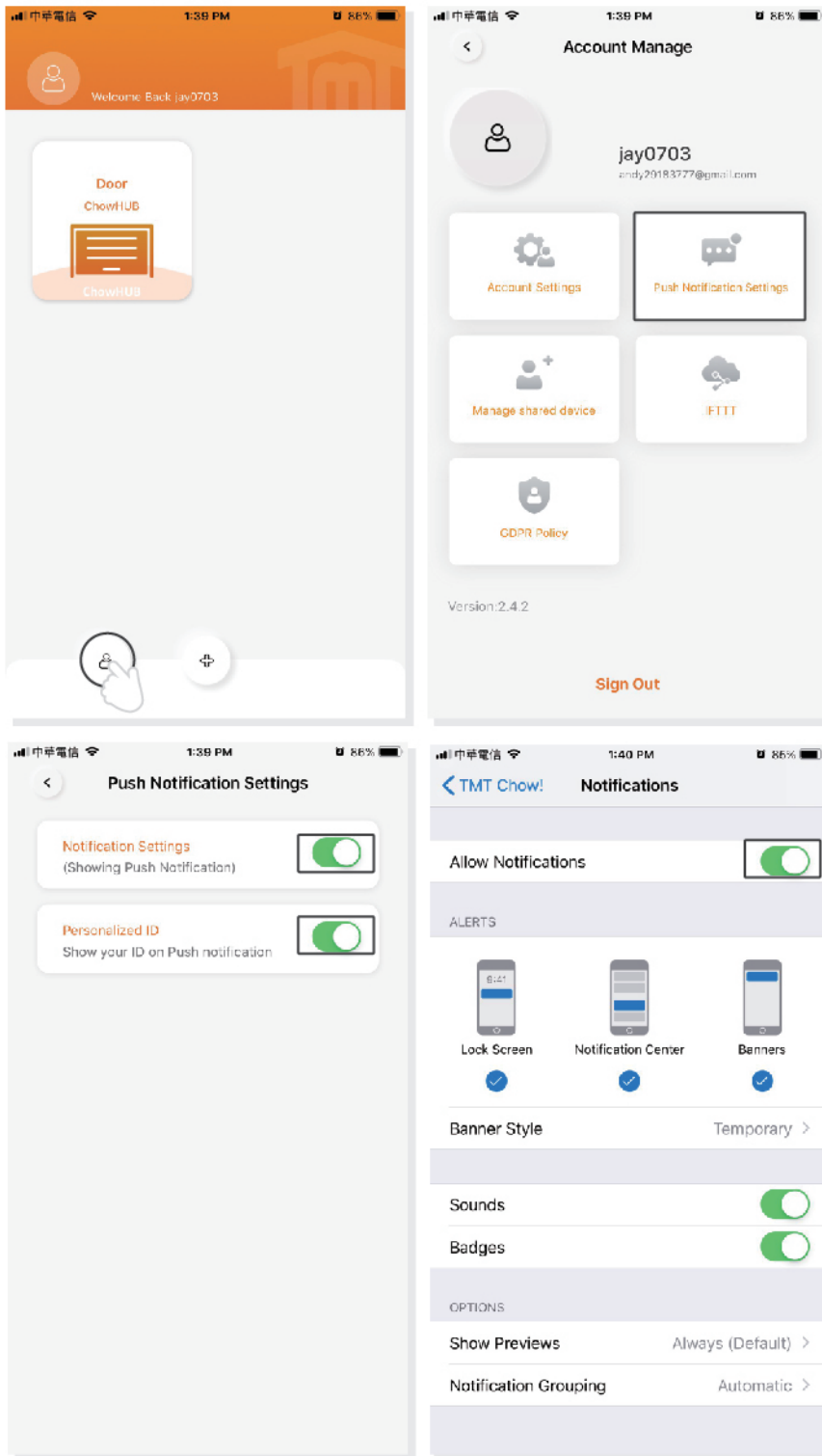

Owner shares device

1. Press the icon at the button left to enter the account management page.
2. Tap the manage shared device.
3. Enter the account which you are going to share.
4. Choose the device you are going to share and tap next.

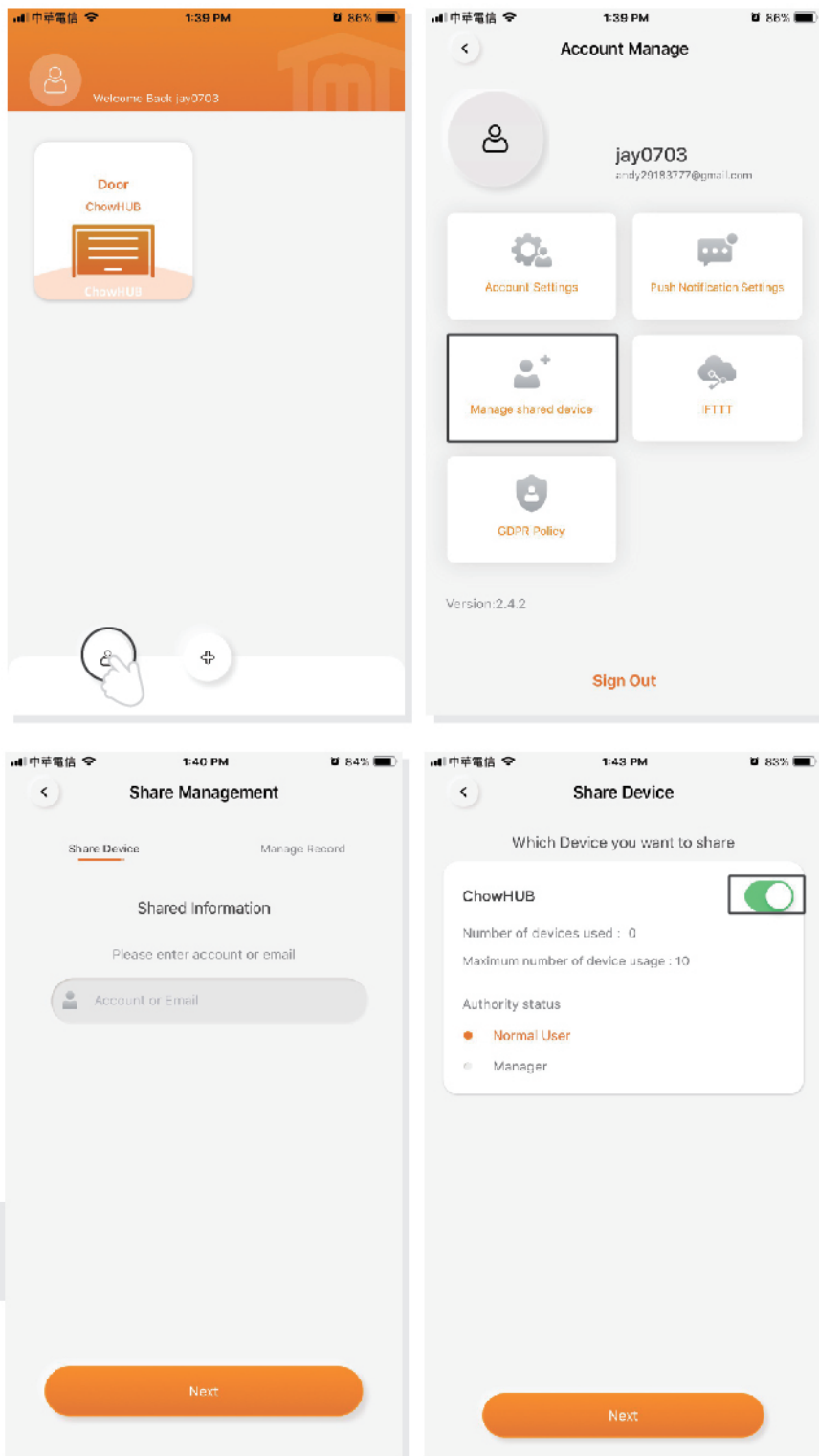

FAQ

Question 1

The blue LED is **NOT** blinking when the ChowHUB connects to the power plug.

Answer 1

Press the **P** button and the blue LED will blink.

Question 2

Blue and green LED blinks alternatively when connecting to Chow! App by the first user.

Answer 2

Entering a wrong password to your Wi-Fi network.

Question 3

Red LED blinks when connecting to Chow! App by the first user.

Answer 3

The ChowHUB cannot identify the IP from the router.

Please turn off the router, turn on, and then reconnect again. Or please connect to other router.

Question 4

Red LED blinks when Enter the PIN code.

Answer 4

Entering the wrong PIN code. Please confirm the correct PIN code with the first user.

Question 5

Green LED blinks.

Answer 5

The Wi-Fi signal is weak. Please adjust the antenna of the ChowHUB or adding an Wi-Fi amplifier to enhance the Wi-Fi signal.



Question 6

Red LED stays ON.

Answer 6

Red LED stays ON indicates a system error. Please press the **R** button.

Question 7

Default to factory setting.

Answer 7

Default to factory setting will be applied when you lose your PIN code for sharing the device. After defaulting, please follow the previous indications to reconnect the ChowHUB to Wi-Fi network.

1. Tap the ChowHUB icon on the main page for 3 seconds and delete the ChowHUB
 2. Open the ChowHUB, press the **P** button for 5 seconds and release it. The Green LED will blink once.
 3. Press the **R** button. When the Blue LED blinks, it means the ChowHUB is successfully defaulted.
-

Question 8

Change the PIN code.

Answer 8

Enter the operation page of the device in Chow! App ➔ Tap the (Device information) in the setting page
➔ Tap (Pin code Setting) to set a new PIN code

Question 9

Change to another Wi-Fi network.

Answer 9

Enter the operation page of the device in Chow! App ➔ Tap the (Device information) in the setting page
➔ Tap the Wi-Fi icon to change to another Wi-Fi network